

TYPE 67 STUFFING TUBE

FOR ELECTRICAL CABLES ENTERING SHEET METAL ENCLOSURES

9000-S6202-74269
BRASS 90 DEGREE TYPE 67
BRASS TUBE, GLAND NUT AND GLAND RING

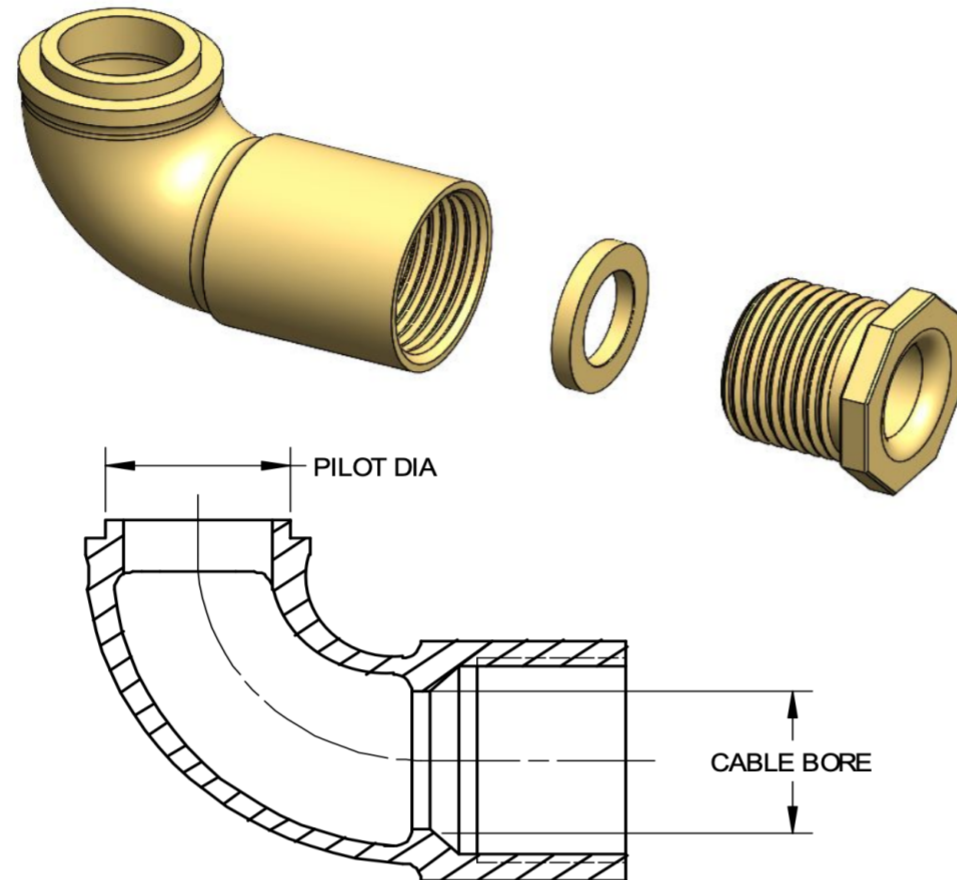

PREFORMED PACKING
MIL-P-16685
(SOLD SEPARATELY)



SIZE	CABLE BORE	PILOT DIAMETER	SYMBOL #	TYPE - SIZE	PENN EL PART #	PREFORMED PACKING #
A	0.406	0.660	1990.1	TYPE 67 - SIZE A	A67-BR-A	MP-BA-A2
B	0.515	0.660	1990.2	TYPE 67 - SIZE B	A67-BR-B	MP-BA-B2
C	0.640	0.957	1990.3	TYPE 67 - SIZE C	A67-BR-C	MP-BA-C2
D	0.750	0.957	1990.4	TYPE 67 - SIZE D	A67-BR-D	MP-BA-D2
E	0.812	0.957	1990.5	TYPE 67 - SIZE E	A67-BR-E	MP-BA-E2
F	0.843	0.957	1990.6	TYPE 67 - SIZE F	A67-BR-F	MP-BA-F2
G	0.953	1.207	1990.7	TYPE 67 - SIZE G	A67-BR-G	MP-BA-G2
J	1.062	1.207	1990.8	TYPE 67 - SIZE J	A67-BR-J	MP-BA-J2
K	1.171	1.207	1990.9	TYPE 67 - SIZE K	A67-BR-K	MP-BA-K2
L	1.265	1.551	1990.10	TYPE 67 - SIZE L	A67-BR-L	MP-BA-L2
M	1.406	1.551	1990.11	TYPE 67 - SIZE M	A67-BR-M	MP-BA-M2
N	1.515	1.551	1990.12	TYPE 67 - SIZE N	A67-BR-N	MP-BA-N2
P	1.625	1.951	1990.13	TYPE 67 - SIZE P	A67-BR-P	MP-BA-P2
R	1.750	1.951	1990.14	TYPE 67 - SIZE R	A67-BR-R	MP-BA-R2
S	1.875	1.951	1990.15	TYPE 67 - SIZE S	A67-BR-S	MP-BA-S2
T	2.062	2.076	1990.16	TYPE 67 - SIZE T	A67-BR-T	MP-BA-T2
V	2.187	2.076	1990.17	TYPE 67 - SIZE V	A67-BR-V	MP-BA-V2

PENN EL SERVICE COMPANY

801 STONY BATTERY ROAD
LANDISVILLE, PA 17538
717-898-2202
pennel@bearonmfg.com
pennel.com

